

See discussions, stats, and author profiles for this publication at: <https://www.researchgate.net/publication/285988329>

# Gas Sensors: A Review

Article in *Sensors and Transducers* · April 2014

CITATIONS

32

READS

14,564

## 4 authors:



**Zainab Yunusa**

Bayero University, Kano

13 PUBLICATIONS 79 CITATIONS

[SEE PROFILE](#)



**Mohd Nizar Hamidon**

Universiti Putra Malaysia

190 PUBLICATIONS 1,282 CITATIONS

[SEE PROFILE](#)



**Ahsanul Kaiser**

4 PUBLICATIONS 43 CITATIONS

[SEE PROFILE](#)



**Z. Awang**

Universiti Teknologi MARA

126 PUBLICATIONS 390 CITATIONS

[SEE PROFILE](#)

Some of the authors of this publication are also working on these related projects:



Read Operation Performance Analysis of Modified Crossbar Array Structures with Self-Rectifying Memristive Device Model [View project](#)



Carbon-based Flexible Sensor [View project](#)

## Gas Sensors: A Review

<sup>1,2</sup> Zainab Yunusa, <sup>1</sup> Mohd. Nizar Hamidon, <sup>3</sup> Ahsanul Kaiser,  
<sup>4</sup> Zaiki Awang

<sup>1</sup> Institute of Advanced Technology, Universiti Putra Malaysia  
43400 Serdang, Selangor, Malaysia

<sup>2</sup> Department of Electrical Engineering, Bayero University Kano  
3011 Kano, Nigeria

<sup>3</sup> Department of Mechanical and Manufacturing Engineering, Universiti Putra Malaysia  
43400 Serdang, Selangor, Malaysia

<sup>4</sup> Faculty of Electrical Engineering, Universiti Teknologi MARA  
40150 Shah Alam, Selangor, Malaysia

<sup>1</sup> Tel.: + 60182324583

<sup>1</sup> E-mail: zee1yunusa@yahoo.com

*Received: 2 November 2013 / Accepted: 7 March 2014 / Published: 30 April 2014*

---

**Abstract:** In this paper a review of different technologies for gas sensors is presented. The different types of gas sensors technologies including catalytic gas sensor, electrochemical gas sensors, thermal conductivity gas sensor, optical gas sensor and acoustic gas sensor are discussed together with their principle of operation. The Surface Acoustic Wave Gas Sensor technology is discussed in greater detail. The advantages and disadvantages of each sensor technology are also highlighted. All these technologies have been used for several decades for the development of highly sensitive and responsive gas sensors for the detection of flammable and hazardous gases. However, for improved sensitivity and selectivity for these sensors, future trends and outlook for researchers are suggested in the conclusion of this article. *Copyright © 2014 IFSA Publishing, S. L.*

**Keywords:** Gas Sensor, Sensitivity, Selectivity, Surface Acoustic Wave.

---

### 1. Introduction

Gas sensors are chemical sensors that are of paramount importance. A chemical sensor comprises of a transducer and an active layer for converting the chemical information into another form of electronic signal like frequency change, current change or voltage change.

As the air surrounding us contains different amount of gases which could be hazardous to human health, atmospheric pollutants or of significance to an industrial or medical process, It becomes therefore very imperative to detect the presence of these gases

since the environment we dwell in consists of humans, plants and animals as its main inhabitants, so the safety of their lives is of topmost priority.

Basically, traditional detection methods which produce systems that sounds an audio alarm to notify people when there is a gas leakage that is harmful or poisonous is not very reliable because it is required to obtain accurate real-time measurements of the concentration of a target gas. However, for many centuries, different gas sensor technologies have been used for different gases detection including semiconductor gas sensors, catalytic gas sensors, electrochemical gas sensors, optical gas sensors and

acoustic gas sensors. The performance characteristic of every sensor is based on some properties including sensitivity, selectivity, detection limit, response time and recovery time.

The sensitivity (S) of a sensor is determined as  $\Delta f/\Delta c$ , where  $\Delta c$  is the change in analyte concentration. S is expressed in terms of Hz/ppm or Hz/vol %. Selectivity refers to the characteristics that determine whether a sensor can respond selectively to an analyte or a group of analytes. Detection limit is the lowest concentration of the analyte that can be detected by the sensor under given conditions. Response time is the time it takes for the sensor to respond to a step concentration change. Recovery time is the time it takes for the signal to return to its initial value after a step concentration value.

Other factors that makes a sensor more attractive to consumers include small size, low power consumption and capability of being wireless. In order to have knowledge on development of gas sensors, Some reviews have been made on different gas sensors, L. M. Dorozhkin [1] and I. A. Rozanov made a review paper on acoustic wave chemical sensors for gases. A review was made by T. Hubert [2] on Hydrogen gas sensors. In this paper, a review of different gas sensor technologies is presented for the detection of different target gases without emphasis on a particular gas.

## 2. Different Gas Sensor Technologies

In this section a review on the different types of sensors and their principle of operation will be discussed.

### 2.1. Catalytic Sensors

Catalytic sensors have been in use for almost a century for the detection of combustible gases. The first catalytic combustion type sensor was discovered by Jonson in 1923 [3, 4] and was used for the detection of methane in mines.

#### 2.1.1. Principle of Operation

Most metal oxides and their compounds possess catalytic property. Combustible gas mixtures do not burn until they attain a certain ignition temperature, but in the presence of a particular chemical process the gas will begin to ignite even at lower temperatures. This process is known as catalytic combustion. A gas sensor made on the basis of catalytic principle is called catalytic gas sensor. A Wheatstone bridge is used to measure the output of catalytic gas sensor. The catalytic gas sensor is divided into two namely, pellistor type and thermoelectric type The earliest catalytic gas sensor was simply a coiled shaped platinum wire as shown

in Fig. 1(a), this was used to produce an efficient heating and a strong signal for a gas sensor, but despite the excellent properties of platinum, it is a poor catalyst for combustion of hydrocarbon gases.

The temperature needed for the detection of hydrocarbons is between 900 °C to 1000 °C, but at this temperature the platinum starts to evaporate and as such resistance of the platinum wire increases. Another problem with the platinum wire is that at the temperature of 1000 °C the platinum becomes soft. The solution to this problem is to coat the platinum with other metal oxides and finally treat the sensor with a catalyst like platinum, palladium or thoria compounds. Fig. 1(b) shows a catalytic bead sensor with the metal oxide coating, the coating makes the sensor more rugged, more stable and resistant to shock and vibrations.

Recently, microhotplates have been widely used in gas sensors instead of using platinum coil due to the high power consumption. This type of sensors usually contains a catalytic surface coated on a hot plate with Pt resistor that heats up the catalyst to a very high temperature at which any flammable gas molecules can ignite. The concentrations of gases can be detected by monitoring resistance change of the platinum resistance arising from increase in temperature. This design was recently developed by Lei Xu et al [5] in which they design and fabricate a two-beam microplate for catalytic gas sensors. The two-beam microplate was designed using MEMS technology as shown in Fig. 1(c). Their design manifested a low power consumption with a 30 % power per active area as compared with other microhotplates and a sensitivity of the sensor to 50 % LEL methane was 2.4 mV/ % methane.



Fig. 1(a). Hot Wire Sensor [6].

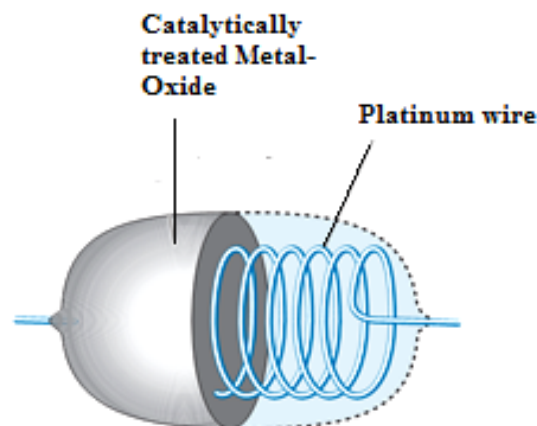

Fig. 1(b). Catalytic bead Sensor [6].

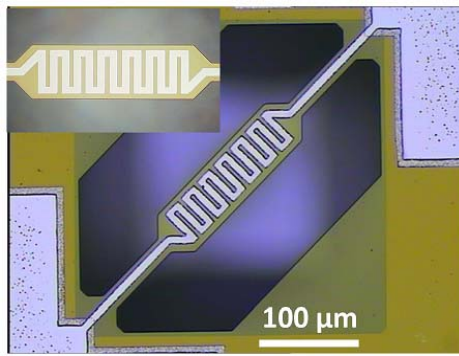

Fig. 1(c). Microhotplate sensor [5].

### 2.1.2. Pellistor-Type Catalytic Gas Sensor

A Pellistor-type catalytic gas sensor depicted in Fig. 2(a) consists of two platinum coils which has 2 functions viz; they serve as heater as well as resistance thermometer. It also consists of active and inactive beads. The active bead is activated with catalyst made from a metal like platinum or palladium. The inactive bead has no catalyst but usually acts as compensating elements. A voltage supply use for powering the circuit heats up the coils so that the beads are raised to a high temperature from a range of 300°C to 500°C depending on the target gas. This causes the gas to ignite and raises the temperature of the detector coil.

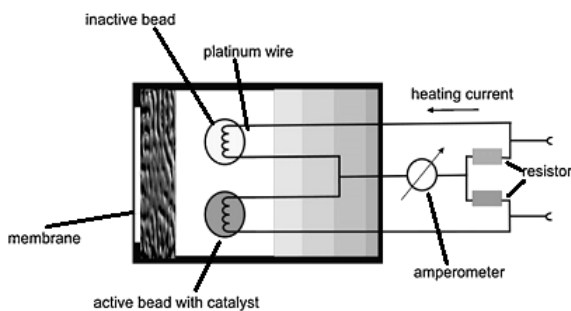

Fig. 2(a). Pellistor-type gas sensor [2].

This rise in temperature increases the coil resistance and causes an imbalance in the voltage of the Wheatstone bridge which constitutes the sensor signal. The output of the sensor is taken across the Wheatstone bridge circuit shown in Fig. 2(b). Recent researches as reported by Lei Xu et al [6] developed a catalytic combustion type methane detection sensor with a Pd-Pt catalyst working on pulse voltage mode. The sensor was fabricated by micromachining and sol-gel process on a silicon substrate. The output of the gas sensor is measured by a bridge circuit shown in figure which consists of a resistive sensing element, microhotplate with a Pd-Pt/ $\gamma$ -Al<sub>2</sub>O<sub>3</sub> layer, a variable resistor R and two fixed resistors R<sub>1</sub> and R<sub>2</sub>. Test results showed increased sensitivity under pulse voltage mode as compared with 2 mV/%CH<sub>4</sub> under

constant voltage of 1.3 V. The same author [6] recently published a paper on a suspended-membrane-type hotplate with high efficiency for catalytic gas sensors. Test results also showed high sensitivity towards methane detection.

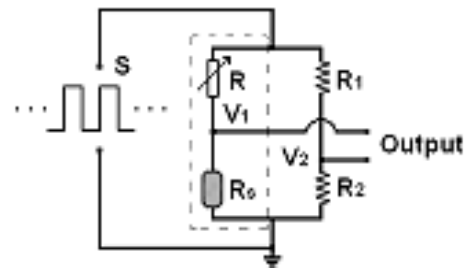

Fig. 2(b). Wheatstone bridge setup for methane gas detection.

The pellistor technology has witnessed significant development by using micro-electrochemical systems (MEMS) technology for their fabrication due to the advantage of integration, miniaturization and reduced power consumption. Catalytic gas combustion gas sensors have been manufactured using thin film or micromachining techniques. Eui-Bok et al [7] recently developed an integrated catalytic combustion H<sub>2</sub> sensor using MEMS technology.

The novelty of their design was that the gas sensors were manufactured with two sensing elements and 2 reference elements using MEMS technology.

### 2.1.3. Thermoelectric Gas Sensor

The earliest thermoelectric gas sensor was developed by McAleer in 1985 for the detection of combustible gas like hydrogen gas as reported by [8, 9]. Hydrogen detection using thermoelectric sensor is possible by producing an electrical signal based on the catalyzed exothermic oxidation reaction of hydrogen. Thermoelectric gas sensors work on the principle of the Seebeck effect. The Seebeck effect occurs as a result of a temperature difference between two points of a conductor or semiconductor material which gives rise to a voltage difference between these points.

Thermoelectric sensors have been manufactured using micromachining techniques, A microelectric gas sensor for the detection of hydrogen and atomic oxygen was reported by Se-Chuk Park et al [10] using surface micromachining technique for the sensor fabrication. The sensor senses the gases by measuring the reaction heat of the catalytic reaction between a novel metal catalyst using Cu-Bi thermopiles. Hydrogen recently reported thermoelectric sensors were used for the detection of volatile organic compounds by the use of tin oxide thin films. The principle of gas sensing using

thermoelectric gas sensors is usually based on gas adsorption. However this technique usually slows down the response and recovery times. Seung-II Yoon et al [11] designed and fabricated a thermoelectric gas sensor based on the principle of gas adsorption instead of gas absorption as shown in figure. The sensor uses an embedded tin oxide catalyst for the detection of hydrogen and  $\text{NO}_x$  gases. MEMS technology was employed for the sensor fabrication on a pyrex substrate. To realize the principle of gas adsorption, a sensing and a reference thermopiles with bismuth and chrome pairs were used. A thermopile was used so as to create an electric potential that is proportional to the temperature difference between the hot and cold junctions without the need of power consumption while a catalyst film is placed underneath the hot junctions of the thermopile.

A thermoelectric gas sensor for the detection of volatile organic compounds was designed and developed by S. Anuradha et al [12] in which chromium metal films were deposited on the glass substrate so as to increase the Seebeck coefficient of the sensor and tin oxide films were later deposited. The sensor was tested for response towards Volatile Organic Compounds namely ethanol, isopropyl alcohol and hexane in the temperature range of about  $80^\circ\text{C}$  to  $160^\circ\text{C}$ . The sensors developed with and without the metal films were tested for their response to acetone gas. Sensors with chromium metal showed good sensitivity to acetone as low as 28 ppm and was found to be selective towards acetone gas.

## 2.2. Thermal Conductivity Gas Sensor

Thermal conductivity measurements for gas analysis have been used for many decades [2]. It is usually used for the detection of gases with high thermal conductivities greater than air like hydrogen and methane while gases with conductivities close to air cannot be detected like ammonia and carbon monoxide. Gases with thermal conductivities less than air are difficult to detect using this method due to interference example carbondioxide and butane.

Their principle of operation is based on the measured heat loss from a hotter body to the cold element through thermal conductivity. The first type of thermal conductivity gas sensor is called pellistor-like sensor and consists of two inert resistor beads with an implanted thermoresistor. The sensing resistor is usually located within a gas chamber which contains a reference gas. Similar to a catalytic gas sensor a Wheatstone bridge circuit is also employed whereby the two beads are connected. The principle behind the detection mechanism is such that when the resistor is exposed to the target gas mixture, heat is lost which is either higher or lower depending on the thermal conductivity of the target gas with respect to the reference gas. This however leads to an increase or decrease in the temperature of the bead and also a change in its resistance which is measured

as an imbalance in the Wheatstone bridge. The second type of sensor does not require the use of reference cell. It is made up of a hot and cold element which has a known and a constant temperature difference. The heat is transferred from the hot element to the cold element by means of thermal conductivity of the investigated gas.

Pascal Tardy et al [13] developed a dynamic thermal conductivity sensor based on the transient response of a SiC microplate for the determination of carbon monoxide content in hydrogen and methane. Isolde Simon and Micheal Arndt [14] designed a simple micromachined thermal conductivity sensor. Experiments carried out showed good sensor performance predicted by the model. The sensor chips were used to build a hydrogen detector for automotive applications.

Recently, micromachining have been employed for hydrogen gas detection due to miniaturization and reduced power consumption. G. de Graaf et al [15] recently developed a thermal conductivity gas sensing which uses MEMS technology for the fabrication of high sensitivity thermal sensors for hydrogen detection. Analysis showed that the performance of surface-micromachined devices could be better than that of bulk-micromachined devices. The sensitivity for hydrogen in air was found to be  $60 \mu\text{V}$  per %  $\text{H}_2$  at 1 mW heater dissipation. Fig. 3 shows a cross section of the fabricated microTCD which is fabricated on a silicon wafer. It is made up of thermopile temperature sensors which depends upon the decrease in effective thermal resistance between the sensitive area of the sensor and the substrate by the thermal conductance of the gas in the thin membrane. The heating element is a resistor which is located in the middle of the membrane. A gas chamber is located for the hydrogen sensing.

## 2.3. Electrochemical Gas Sensors

These types of sensors allow gases to diffuse through a porous membrane to an electrode where it is either reduced or oxidized at the electrode.

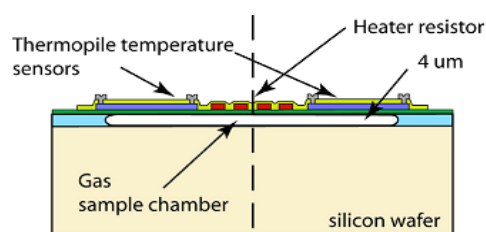

Fig. 3. Micro-thermal conductivity gas sensor [15].

Electrochemical sensors operate by reacting with a target gas and producing an electrical signal that is proportional to the gas concentration. A typical electrochemical gas sensor consists of a sensing electrode or working electrode and a counter

electrode which are separated by a thin layer of electrolyte. Before the gas comes in contact with the sensor, it goes through a thin capillary-type opening and then diffuses through a hydrophobic barrier before finally reaching the electrode surface. The function of this membrane is to prevent liquid electrolyte from leaking out and generate enough electrical signal at the sensing electrode. It also consists of a reference electrode whose function is to maintain a stable and constant potential at the sensing electrode due to the continuous electrochemical reactions occurring on the electrode surface. The electrochemical reaction with the target gas generates a flow of current flow between the sensing and counter electrodes. The electrolyte is responsible for carrying the ionic charges across the electrode.

The earliest electrochemical cells were reported by Kohlraush [2] in 1885 and Haber [2] in the early 1900s. Since after that a lot of researchers have worked on electrochemical gas sensors for detection of different gases. J. F. Currie et al [16] developed micromachined thin solid state electrochemical sensor for simultaneous detection of CO<sub>2</sub>, NO<sub>2</sub> and SO<sub>2</sub> gases. Similarly, R. Sathiyamoorthi et al [17] developed an electrochemical sensor for the detection of fluorine and chlorine. In order to improve the sensitivity of the electrochemical gas sensor, Tian Gan and Shengshui Hu [18] published a review paper on Electrochemical sensors based on graphene materials, due to the fact that nanoscaled materials are good candidates for gas sensing elements due to high surface-to volume ratio, they have reduced size and reduced power consumption and have been used for the detection of various gases as shown by Lu et al [19] However, microelectronic systems (MEMS) have been employed for the design of electrochemical microsensors and efforts have been made to improve their sensitivity as shown by [20]. They explained that improved sensitivity could be attained by coating nanosensors developed from carbon nanotubes with polymers.

An electrochemical sensor can be used for measuring carbon monoxide by undergoing a chemical reaction as follows:

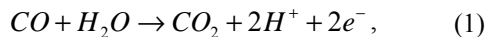

As shown in equation (1), Oxidation reaction takes place at the sensing electrode, CO<sub>2</sub> diffuses into the air and the positively charged ions migrate into the electrolyte.

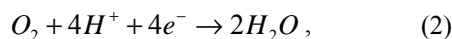

The oxidation reaction is balanced by a corresponding reduction reaction at the counter electrode as shown in equation (2). At one electrode, water is consumed while electrons are generated and at the other electrode water is created while electrons are consumed. The carbon monoxide generated

diffuses in the air and the positively charged hydrogen ions travel down to the electrolyte.

Similarly, for hydrogen the electrochemical reaction is as shown in equation 3, Hydrogen gas diffuses and becomes oxidized at the sensing electrode. This reaction causes a change in the potential of the sensing electrode and thus reduction of oxygen takes place as shown in equation 4.

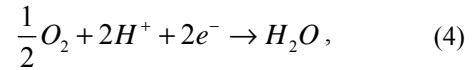
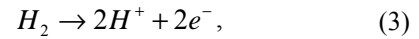

The result of the flow of electrons from anode to the cathode constitutes an electric current that is proportional to the hydrogen gas concentration which obeys Faraday's law.

$$i = Z.F.Q, \quad (5)$$

where  $Z$  is no of exchanged electrons/molecules,  $Q$  is the conversion rate of hydrogen in moles/second,  $F$  is Faraday constant = 96486.7 As/mol.

Electrochemical sensors are usually of three types namely: amperometric, potentiometric and conductometric which are discussed below:

### 2.3.1. Amperometric Gas Sensor

The amperometric sensors work at a constant applied voltage and the sensor signal is a diffusion limited current. It usually consists of two electrodes, the working electrode and the counter electrode and also a reference electrode which are immersed in the electrolyte solution and a potentiostat for maintaining constant voltage as shown in Fig. 4.

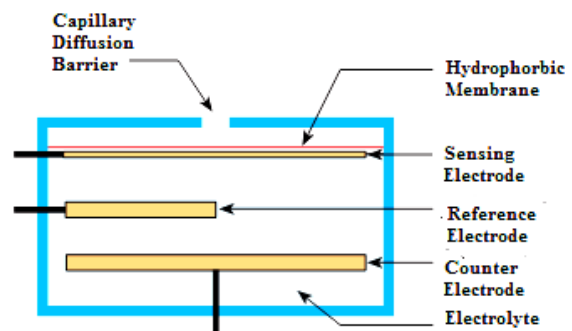

Fig. 4. A typical electrochemical gas sensor [21].

Amperometric sensors are usually built using two-electrode configuration but due to the limits of the concentrations of reactant gas they are built using a three electrode scheme. In the three electrode configuration, the current at the sensing electrode can be measured at a constant potential which gives a

genuine thermodynamic potential for all reactions, in this case the reference electrode is not involved in the reaction. However, the current generated as a result of the target gas at the sensing or working electrode is measured as the sensor signal which can then be measured at either a fixed or variable electrode potential.

Amperometric sensors have been used for detecting various gases by changing the type of electrolyte. Alex Moreta et al [22] developed a novel design for an amperometric gas sensor with the use of an yttria stabilized zirconia (YSZ) porous layer which acts as an oxygen conductor and a gas diffusion barrier. The planar stack configuration was developed and allowed a deposition of YSZ layers. The device developed showed a linear output in the range of oxygen partial pressures. Kuo-Chuan Ho and Wen-Tung Hung [23] also developed an amperometric NO<sub>2</sub> gas sensor based on Pt/Nafion electrode, NO<sub>2</sub> concentrations in the range of 0 to 485 ppm were detected. Similarly an amperometric hydrogen sensor was developed based on polymer electrolyte membrane with Nafion membrane as the conducting polymer. The response to hydrogen concentration was in the range of 260 to 11,500 ppm Yente Chao et al [24] developed an amperometric sensor using 3 different sensor designs for hydrogen and carbon monoxide sensing. The three different designs were tested under hydrogen and CO concentration and devices II and III were found to have slower response times as compared to device I. Selectivity of the sensor under hydrogen concentrations was greatly improved by replacing Pt-air RE with modified Ag/AgCl RE and incorporation of a semi-permeable membrane. Amperometric gas sensors for the detection of hydrocarbon was reported by [25] for monitoring in exhaust pipes.

With the advent of Microelectronics System (MEMS), microelectrodes with very small electrode surface area have been employed in the fabrication of electrochemical sensors due to their numerous advantages of having small size and weight, low cost, faster response time without affecting the signal-to-noise ratio. Microamperometric sensors dated back in the 1980's consisted only of microfabricated electrodes on a suitable substrate, the earliest microamperometric sensor was developed by Sleszynski and Osteryoung in 1984. Recently, techniques on how to improve the sensitivity of the sensors were reported by [26, 27].

### 2.3.2. Potentiometric Gas Sensors

Potentiometric gas sensors are used to determine the analytical concentration of some components of the analyte gas. They can measure the electrical potential of an electrode without current flow. The signal is measured as the potential difference between the working electrode and the reference electrode. Potentiometric sensors have been used for oxygen detection. A typical potentiometric oxygen sensor is

made up of an oxygen ion conducting solid electrolyte and two electrodes which are deposited on the two sides of the electrolyte. One of these is a reference electrode which is in contact with a known oxygen partial pressure while the other is a working electrode which is in contact with an unknown oxygen partial pressure that needs to be measured. When the electrodes are in contact with two different oxygen partial pressures and isolated from each other, an EMF is developed by the sensor. The EMF is described by Nernst equation:

$$E = \frac{RT}{4F} \ln\left(\frac{P_r}{P_w}\right), \quad (5)$$

where  $P_r$  is the partial pressure of oxygen at the reference electrode and  $P_w$  is the partial pressure at the working electrode, R is the gas constant, T is the temperature in Kelvin and F is the Faraday's constant. These sensors usually operate between 600 °C and 1000 °C.

The electrodes are usually made from Palladium, Platinum, gold or silver. Different electrolytes have been also used or a combination of two materials for the detection of different gases. C. Lee et al [28] developed a potentiometric CO<sub>2</sub> gas sensor using lithium phosphorus oxynitride electrolyte while recently Jiun-Chan Yang et al [29] developed a high temperature NO<sub>2</sub> sensor fabricated with asymmetric reference and sensing electrode made with Pt and YSZ electrolyte. The combination of these two materials have simplified the design and make it more compact. Similarly, Yongtie Yan et al [30] developed a potentiometric sensor using stabilized zirconia for chlorine gas by combining MgO-stabilized zirconia tube with an auxiliary phase containing metal chloride with a sensitivity of 1-100 ppm of chlorine at 550-600 °C. With the advent of microfabrication technology, miniaturized sensors are produced so as to amplify the output of the potentiometric sensors. R. Radhakrishnan et al [31] fabricated a miniaturized series connected potentiometric sensor on a silicon fabricated electrodes on after using microfabrication techniques for oxygen detection.

## 2.4. Optical Gas Sensors

This type of sensors use optical absorption/emission scattering of a gas species at defined optical wavelengths. An optical gas sensor consists of a light emitting element, a photodetecting element, a gas sensing element, the gas sensing element responding to light and a filter for picking up fluorescence or phosphorescence. Most optical sensors are usually based on thin films of palladium or chemochromic oxides coated along the length of an optical fiber. This type of fiber optic sensors are known as optodes. One of the most common optical gas sensors is infrared gas sensors which will be discussed later in more detail.

As shown by many authors, optical sensors have been used for many years in the detection of flammable gases like hydrogen [2]. The first optical hydrogen gas sensor was reported by Butler [2] in 1984 which consists of an optical fibre with Palladium and Titanium coatings. Detection of hydrogen was made using interferometry. Crawford Massie et al [32] also designed a low-cost portable optical sensor for methane detection with very good sensitivity, the sensor can operate even in harsh environments. L. N Acquaroli et al [33] designed an optical porous silicon gas sensor. The system was tested over a detection area of the porous silicon microcavity with isopropyl alcohol vapor and even small changes in concentrations were detected. H. Manap et al [34] developed an optical fibre sensor for the monitoring of ammonia gas using an open optical path techniques. Cross sensitivity of CO<sub>2</sub> and O<sub>2</sub> was also tested to see their effect on ammonia gas. S. Okazaki et al [35] also developed a fiber optic hydrogen gas sensor using catalyst-supported-tungsten trioxide (WO<sub>3</sub>). The sensor used platinum acid at 500°C and showed good response towards hydrogen gas detection and can detect gas even at room temperature. M. Girschikofsky et al [36] recently reported an optical planar Bragg grating sensor which is capable of detecting substances like benzene, toluene and xylene. Results obtained showed good sensitivity towards these gases.

## 2.5. Infrared Gas Sensor

Infrared sensors consists of a detector which converts electromagnetic radiation energy into electrical signals. The Detectors are of different types namely: Thermoelectric, Thermistor Bolometer, Pyroelectric detector and Photon detector. It also consists of an infrared source which could be a regular incandescent light or a heated wire filament which can be used for the detection of CO<sub>2</sub>, CO and other hydrocarbons. Another component is an optical fibre which could be of two types: dispersive and non-dispersive.

Non-dispersive types use discrete optical bandpass filters and are mostly used for gas sensor applications while the dispersive types use an optical device like a grating or prism. The last but not the least is the gas cell which allows the light path so as to interact with the target gas. Infrared gas sensors are used for detecting different gases like methane, ethane, propane, butane, benzene toluene, xylene and other alcohols like methanol, ethanol etc. H. Okajima et al [37] developed an Infrared gas sensor using LED for the measurement of methane, absorption of gas samples between 0-97 % were successfully measured, D. Garcia Romeo et al [38] developed a Non-Dispersive Infrared (NDIR) gas sensor for the measurement of CO<sub>2</sub> gas concentration for wireless sensor networks with low power consumption Similarly Dong Chen et al [39] designed a tunable diode laser absorption spectroscopy for the

measurement of hydrogen sulfide gas. In order to produce a sensor that is miniaturized, Guangjun Zhang et al [40] developed a miniaturized CO<sub>2</sub> sensor based on infrared absorption.

There are two types of optical structure which is used for the construction of infrared CO<sub>2</sub> gas sensors namely: time-double beam and space-double beams. The time-double beam optical structure has only one infrared beam emitted from the infrared source and the detector receives 2 infrared beams with different wavelengths and at different times while the space double beam structure has one infrared beam emitted from the infrared source and simultaneously enters two parallel plate detectors In this design, the space double beam is used so as to enhance the construction and a cone-shaped air chamber is designed As shown in Fig. 5 the optical probe consists of an infrared source, an air chamber, an infrared receiving device and two sapphire windows. The sensor showed an accuracy of 0.026 % with CO<sub>2</sub> gas concentration in the range of 0-3 %. Naoya Kasai et al [41] investigated the ability of a system using a carbon infrared emitter and an Infrared camera to detect a combustible gas propane.

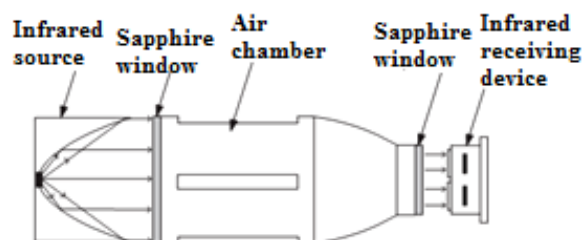

Fig. 5. Showing a structural optical probe [37].

## 2.6. Semiconductor Sensors

Semiconductor gas sensors are devices that are made up of heated metal oxides which are used for measurement of gas concentration of a target gas by measuring the electrical resistance of the device. They work on the principle of reversible gas adsorption process at the surface of the heated oxide usually oxides of tin deposited on a silicon slice by chemical vapor deposition method. Absorption of the sample gas on the oxide surface followed by catalytic oxidation results in a change of electrical resistance of the oxide material which is then related to the sample gas concentration which is monitored by the meter as shown in Fig. 6. The heater at the base is used for heating up the sensor to a constant temperature of about 200-250 °C so as to speed up the reaction rate.

An intrinsic n-type semiconductor is suitable for detecting reducing gases due to the high conductance change as a result of the injected electrons. Similarly, a p-type semiconductor is suitable for the detection of oxidizing gases. The oxides usually used for the n-type are mainly oxides: SnO<sub>2</sub>, ZnO, In<sub>2</sub>O<sub>3</sub>, or WO<sub>3</sub>. They are commonly used to detect hydrogen, oxygen,



alcohol and harmful gases like carbon monoxide. Gas sensors using metal oxide semiconductor were first proposed by Seiyama and Taguchi. When inflammable gases come into contact with metal oxides, they excite a new electron level within the solid and thus cause a change in electrical resistance of the gas sensing elements. Jin Huang and Qing Wan published a review paper on the progress in gas sensors based on semiconducting metal oxide one dimensional (1D) nanostructures.

It was reported that due to the advent of microelectronics, new device structures such as the electronic nose and the low power consumption self-heated gas sensor have been designed and their response been evaluated [42]. Sensitivity and selectivity could be improved by the addition of small amounts of noble metals like Pd-added elements. A. Khodadadi et al [43] reported on improving the sensitivities of methane and carbon monoxide gases by adding 5 % of  $K_2O$  into  $SnO_2$  samples, the sensitivity was improved by 40 %.

Similarly, 5 % of  $Na_2O$  in  $SnO_2$  layers showed reduction of sensor sensitivity to CO. Addition of platinum into the prepared samples improves the response to methane. While addition of small amount of cerium oxide showed suppression of the sensor response to methane while maintaining sensitivity to CO.

However, improved sensitivity could also be obtained by the addition of doping agent in thick film semiconductor gas sensor developed for the sensing of methane and butane.

The semiconductor gas sensors have different configurations, one-electrode and two-electrode configuration.

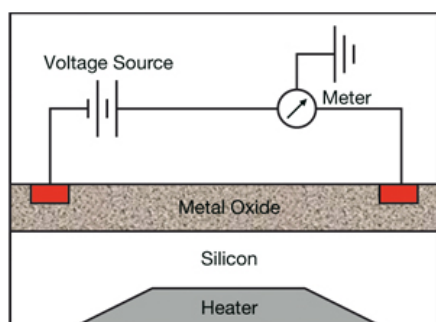

Fig. 6. A typical semiconductor sensor [44].

### 2.6.1. Operation Principle of One-electrode Semiconductor Gas Sensors

The one-electrode sensor configuration is depicted in Fig. 7 as reported by [45] the metal resistor acts as both the heater and measuring electrode at the same time. One electrode sensors are similar to pellistors or hot wire sensors. The operation principle of one-electrode sensor is based on the shunting of the Pt wire by semiconductor oxide coating the metal spiral. The one-electrode sensors are typically incorporated

in a Wheatstone bridge circuit and they work under a stabilized constant current. The shunting semiconductor resistance should be ensured to have a resistance value of the same order of magnitude as that of the Pt resistor at the operation temperature. Due to the low heater resistance, only metal oxides with high conductivity are capable of changing the total resistance of sensors in the presence of gases detected. For one-electrode semiconductor sensor design  $SnO_2$  and  $In_2O_3$  have been used. However, the two-electrode configuration will not be discussed because it is not very common.

The gas sensing materials for one-electrode sensors are deposited using Chemical Vapour Deposition, Physical vapor deposition and Sol-gel Process. Recently, Kengo Shimanoe et al [46] developed a semiconductor nano-sized oxide for the detection of inflammable gases, odor gases and other environmental related gases using MEMS technology with low power consumption. T. Takada [47] developed a new method for gas identification of different gases including hydrogen, carbon monoxide, methane and Volatile organic compounds. Recently, artificial intelligence techniques are integrated into gas sensors as shown by Byeongdeok Yea et al [48]. A method of estimation of semiconductor gas sensor that utilizes neural networks and fuzzy inference systems.

In order to improve sensitivity of the sensor different methods had been used including temperature modulation, synthesis of new sensor materials, designing new sensor constructions, adoption of new filter layers and using of sensor array. Therefore, Grzegorz Halek et al [49] made a comparison on methods of selectivity improvements of semiconductor gas sensors and concluded that the kind of sensing material and filter layer have a strong influence on the sensor parameter.

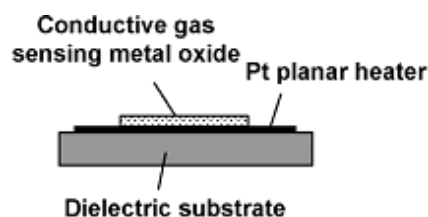

Fig. 7. Showing one electrode configuration of semiconductor gas sensor [40].

### 2.7. Acoustic Wave Gas Sensors

Acoustic wave sensors are so named because their detection mechanism is a mechanical, or acoustic, wave. As the acoustic wave propagates through or on the surface of the material, any changes to the characteristics of the propagation path affect the velocity and/or amplitude of the wave. Changes in velocity can be monitored by measuring the frequency or phase characteristics of the sensor and can then be correlated to the corresponding physical

quantity being measured. An acoustic wave sensor contains a receptor which is an element that is sensitive to an analyte and a transducer i.e. an element that converts the response into an electrical signal.

The first acoustic gas sensor was discovered by King in 1964 [50] and was based on the measurement of bulk acoustic waves (BAW) in a piezoelectric quartz crystal resonator which is sensitive to mass changes. After intensive research studies in mid 1960's, chemical sensors for industrial atmospheric pollutants were developed. Since piezoelectric quartz resonators were used, these type of sensors were called quartz microbalances (QMB).

There are different types of acoustic wave sensors which are based on the type of wave propagation. Acoustic wave sensors have a variety of applications as in temperature, pressure, mass, chemical etc. In this paper the application will be for gas sensing. The principle of operation of acoustic chemical sensor is described as follows. When a receptor film is introduced unto the vibrating surface of a transducer that is activated by an electronic device, the characteristics of the receptor film such as its mass and thickness are changed when exposed to an analyte. This change directly affects the vibration frequency, amplitude and phase. The shift is directly proportional to the analyte concentration.

As mentioned in the introduction, the performance characteristic of any sensor is determined by some factors including sensitivity, response time, selectivity, small size and low power consumption. As reviewed by several works on different gas sensors, the current trend has taken the direction of developing the gas sensors using microelectronics technology due to its advantage of miniaturization and low power consumption. However, acoustic wave sensors already possess this inherent characteristic and were used in gas sensors since 1964 so this makes it to be an attractive candidate over its gas sensing counterparts. A review on acoustic waves will be made in this section of the paper with emphasis on surface acoustic wave sensors. Another advantage of surface acoustic wave technology is that the gas sensing can be made wirelessly as shown by [51], which makes real online monitoring of the gas sensor possible and eliminates the use of wired cables. This property makes it an attractive candidate for gas detection and makes it superior to other gas sensing techniques. Also High selectivity and sensitivity have also been reported in many saw gas sensing applications [25, 29, 31].

### 2.7.1. Surface Acoustic Wave Gas Sensors

Surface acoustic wave technology refers to the use of the SAW device in several technological applications Surface acoustic waves were first discovered by Lord Rayleigh in 1885. SAW sensors are developed based on Rayleigh waves. A Rayleigh SAW is made up of two mechanical displacement

components in the saggital plane i.e. the plane containing the direction of propagation and the surface normal. For gas sensing applications the choice of piezoelectric substrate determines the type of SAW wave. Rayleigh waves propagate in a thin surface layer, and can penetrate into the substrate at a distance of the order of a wavelength. The velocity of propagation of the wave depends on the substrate material, the crystal cut of the substrate and the working frequency.

Since after the discovery a lot of potential applications have been exploited which amongst them is the sensor applications including chemical, optical, thermal, pressure, acceleration, torque and biological. The main advantages of using SAW technology is high sensitivity, low power consumption, wireless, can be placed on moving or rotating parts and in hazardous environment. The SAW device is also technologically compatible because its fabrication process is similar to that of other microelectronic devices.

### 2.7.2. Principle of Operation

Surface acoustic wave sensors works based on the principle of transduction whereby the sensor converts an input electrical signal into a mechanical wave and reconverts back into electrical signal. This is made possible by means of the interdigitated transducer known as the IDTs which uses the piezoelectric effect. The IDTs are made of electrodes made from either aluminium, gold or platinum. A typical SAW therefore consists of an input and output transducer with spacings between them called a delay-line. The principle of gas sensing in SAW is realized by the application of a sensing material like a thin polymer across the delay line which selectively absorbs the gas or gases of interest as depicted in Fig. 8.

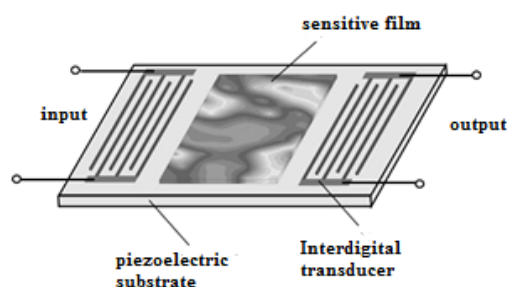

Fig. 8. A SAW device to depict the principle of gas sensing [2].

Rayleigh SAW sensors are based on two types of acoustoelectronic devices namely: delay-line or resonator. The frequency of operation of Rayleigh waves sensors is usually lies between 40-600 MHz. These devices differ in from each other in their design, a delay line has two receiving and transmitting interdigital transducer whereas a resonator has one interdigital transducer placed at the

resonator cavity. However, their mechanism of response is the same and they also have similar output characteristics. A delay line is simpler to design compared with the resonator that is why it is mainly used for practical applications. However, a delay line requires matching due to the insertion attenuation and is subjected to having oscillation frequency, but the resonators have smaller attenuations and do not require matching [52]. A resonator and a delay line could be either single or two-port. A single-port delay line consists of a propagation path between one IDT and one or more interdigital reflectors. A two-port SAW delay line consists of a propagation path between two separate IDTs, the first serves as a transmitting transducer and the second serves as a receiving transducer so as to convert the SAW back to electrical form. The time delay for a two-port delay line is given by

$$\tau_d = \frac{l}{v}, \quad (7)$$

where  $l$  is the mean spacing between the IDTs and  $f$  is the frequency as referred to Fig. 8 (a). Similarly, the

time delay for a two-port delay line is given by 2 equations due to the different lengths of  $l_1$  and  $l_2$  as follows:

$$\tau_{1d} = \frac{2l_1}{v}, \quad (8)$$

$$\tau_{2d} = \frac{2l_2}{v}, \quad (9)$$

where  $l_1$  is the mean spacing between IDT and reflector 1 and  $l_2$  is the mean spacing between IDT and reflector 2. A single-port resonator makes use of one IDT structure in the centre between two reflectors while the two-port resonator consists of two IDT structures in between two reflectors [53]. The function of the reflector is to reflect an incident wave completely over a narrow band of frequency and also to reduce energy loss in the system so that it can produce a narrow and stable signal. Fig. 9(a) ~ Fig. 9(d) shows the different types of configuration of the SAW device for both the delay line and resonator.

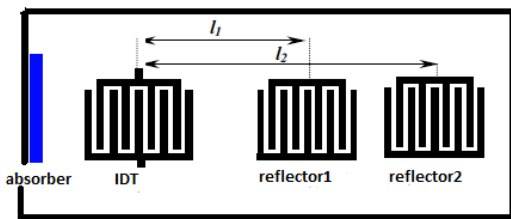

Fig. 9(a). Single-port delay line

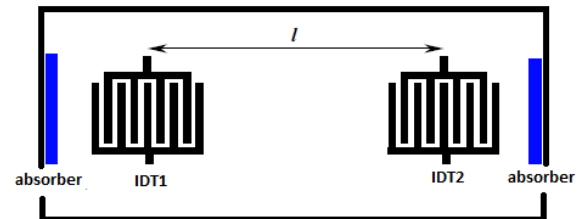

Fig. 9(b). Two-port delay line.

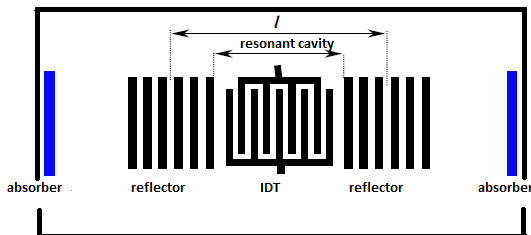

Fig. 9(c). Single port resonator.

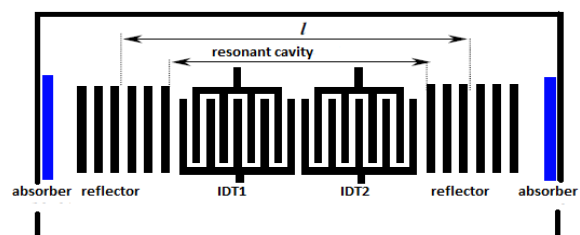

Fig. 9(d). Two-port resonator.

### 3. SAW Based Gas Sensors

Surface acoustic waves were the next generation of acoustic wave sensors after the advent of the quartz crystal microbalance quartz crystal microbalance (QCM) which was used to stabilize the frequencies of radio transmitters and later modified by the addition of sorptive film on the crystal so that it could be used for chemical sensing [54]. Subsequently the device was analyzed and improved

by some researchers in the 1950s. In the late 1970s, Wohltjen and Dessy [55] realized that chemical vapor sensing could be accomplished with a device that was originally used for processing of electrical signals which is the SAW delay-line.

Since then a lot of researchers have been working on SAW sensors for detection of different gases which are either toxic, harmful or pollutants, while others can be used as fuel gases in industries and automobiles. Researchers tend to employ SAW

resonator if their prime interest is to control the centre frequency whereas if the time response is of interest they decide to use the delay line. SAW delay line is commonly used due to its simplicity in the design and fabrication [65]. M. S. Nieuwenhuizen et al [56] developed a SAW gas sensor for detection of CO<sub>2</sub> and H<sub>2</sub>O using dual delay-line oscillators on a quartz substrate at a frequency of 40 MHz. Adrian Venema et al [57] also designed a SAW delay-line gas sensor using quartz substrate for the detection of NO<sub>2</sub> gas. Subsequently, V. I. Anisimkin et al [58] also developed a SAW delay-line gas sensor for the detection of CO, NO, hydrogen and oxygen gases respectively. K. Beck et al [59] also developed a SAW delay-line using lithium niobate substrate for the detection of NO<sub>2</sub> and methane gases. A review

paper was published recently by Wieslaw P. Jakubik on dual delay line oscillator. However, Hea-Min Lee et al [60] designed SAW resonator gas sensor using lithium niobate for the detection of methane and hydrogen gas. Similarly, G. Fischerauer et al [52] also employed a SAW resonator for the detection of hydrocarbons. Due to the good results displayed by the use of saw devices for gas sensing in terms of high sensitivity, selectivity and good response times, A lot of researchers are working extensively so as to detect different gases using different configurations of SAWs and at different frequencies as presented in Table 1. Results obtained have produced excellent results in terms of high selectivity, high sensitivity and good response times.

**Table 1.** Review of SAW gas sensor.

Author/Year	Type Of Saw	Gases Detected	Substrate Material	Frequency	Sensitivity
J. A. Theile 2004 [61]	Two-port resonator	Hydrogen	Langasite	167 MHz	6 - 8 kHz in concentrations between 250 - 1000 ppm of H <sub>2</sub> /N <sub>2</sub>
A. Z Sadek 2005 [62]	Two-port resonator	Hydrogen	Lithium niobate	106.9 MHz	7 kHz towards 1 % of hydrogen in air
A. Z Sadek 2006 [63]	Two-port resonator	CO	Lithium niobate	108.2 MHz	185 kHz towards 150 ppm of CO
Chunbae Lim 2009 [65]	Delay-lines	CO <sub>2</sub> and NO <sub>2</sub>	Lithium niobate	440 MHz	2.12 /ppm for CO <sub>2</sub> and 55.4 /ppm for NO <sub>2</sub>
Cristian Viespe 2010 [66]	Delay-lines	Volatile Organic Compounds	Quartz	69.4 MHz	1.19, 0.79, 0.51 Hz/ppm for MWCNT-PEI, SiO <sub>2</sub> /Si-PEI & PEI respectively
Da-Jeng Yao 2010 [67]	Two-port resonator	Methanol, ethanol, isopropyl, alcohol, acetone, amine	Lithium niobate	99.8 MHz	NIL
Hsu-Chao Hao 2010 [68]	Two-port resonator	Ammonia	Lithium tantalite	100 MHz	NIL
Chi-Yen Shen et al 2010 [69]	Two-port resonator	Ammonia	ST-Cut Quartz	98.47 MHz	5.9 Hz/ppm
T. H. Lin 2011 [70]	Dual delay-line	Ammonia	Lithium niobate	114.7 MHz	6.91 Hz/ppm
Duy-Thach 2012 [71]	Two-port Delay line	Hydrogen	Aluminium nitride/silicon	129.28 MHz uncoated, 128.85 MHz & 126.93 MHz coated Pt/ZnO	55 kHz in 1 % Hydrogen concentration

#### 4. Comparison of Gas Sensors

All the technologies listed above for gas sensing requires optimum performance. Therefore it is necessary for one to have a clear picture of the pros and cons of each type of sensor.

This is dependent on certain operating and environmental conditions as well as the cost of production for each sensor which varies amongst the various classes of technology. A comparison (advantages and disadvantages) of all the gas detection sensors are presented in Table 2.

#### 5. Conclusion

A review of different gas sensors was presented. The different sensing techniques discussed in this article includes catalytic gas sensors, electrochemical gas sensors, optical gas sensors, thermal conductivity gas sensors and acoustic gas sensors. Since the properties of an ideal sensor are defined by some variables which are; sensitivity, selectivity, high response time and fast recovery time. Each of the sensor technologies are working towards getting the optimal properties of an ideal sensor, therefore the trend is to fabricate the sensors to become as

miniaturized as possible. In view of this, all the sensors recently utilize the microfabrication and microfabrication techniques for the sensor fabrication. By adopting this technique, many

solutions are offered including small size, low cost, low power consumption and as well possessing all the characteristics that classify them as an ideal sensor.

**Table 2.** Comparison of gas detection sensor technologies.

No.	Sensor Type	Advantages	Disadvantages
1.	Catalytic	Simple, measures flammability of gases and low cost technology	Requires air or oxygen to work. Can be poisoned by lead, chlorine and silicones
2.	Thermal	Robust but simple construction. Easy to operate in absence of oxygen. Measuring range is very wide.	Reaction due to heating wire.
3.	Electrochemical	Measures toxic gases in relatively low concentrations. Wide range of gases can be detected	Failures modes are unrevealed unless advanced monitoring technique used.
4.	Optical	Easy to operate in absence of oxygen. Not affected by electromagnetic interference. Monitoring area is very wide.	Affected by ambient light interference.
5.	Infrared	Uses only physical technique. No unseen failure modes. Can be used in inert atmospheres.	Not all gases have IR absorption. Sequential monitoring is slower on multi point analyzers and also more user expertise required.
6.	Semiconductors	Mechanically robust, works well at constant high humidity condition.	Susceptible to contaminants and changes due to environmental conditions. Non-linear response effects complexity.
7.	Surface Acoustic Wave	Detect nerve and blister agents Battery-less and could be used for wireless applications. Could be placed in harsh and rotating parts	Due to its small size there is difficulty in handling during fabrication process.

The surface acoustic wave technology possesses all these properties of an ideal sensor and thus it offers one-step solution when adopted. It is the technology that produces a small, low cost and low power consumption devices for gas sensing applications. With the advent of modern technology, there is also need to monitor the gas sensor remotely from a certain location technology especially for pipelines leakages which if not monitored carefully may cause explosion. The surface acoustic wave technology offers this property of the ability to be used as wireless sensors which saves time and energy and also saves real time monitoring of the gas sensor. This wireless capability could be achieved by utilizing the Industrial, Scientific and Medical bands which is free in most countries. To accomplish this, the SAW device that should be used for the gas sensor should have the frequency of 433.92 MHz which is the frequency for the wireless band.

However, the scope of the gases detected by the different sensors should be expanded. Most of the technologies concentrate on the same types of flammable and toxic gases. As safety of humans is of priority, many of these flammable and toxic gases are neglected and therefore future researches needs to explore all the existing hazardous gases so as to make the environment clean and safe. Flammable liquids like butane, benzene, gasoline etc need to be explored as well.

As the sensitivity of a sensor is a very important characteristic for a good sensor. The goal of the researcher is on how to improve the sensitivity of a sensor, the type of sensing layer is a main determining factor to attain this goal. Therefore new sensing materials need to be used for the sensing layer. Future researches should develop new sensing materials for their active layer like graphene and graphite based sensors and also their nanocomposites.

Another promising materials for exploration is silicon and its metal oxide. This was shown by [72] where Nanocrystalline SnO<sub>2</sub>-Pt thick film gas sensor was used for multi-gas sensing of methanol, ethyl alcohol, acetone, isopropanol, and isobutane. Their results showed improved sensitivity and selectivity towards these gases. Therefore, more promising sensitivity could be achieved when SnO<sub>2</sub> is used with carbon composite materials. Alloys of (MnCoNi) oxide could also be promising sensing materials.

Carbon nanotubes have been quite promising materials for gas sensors due to their high-surface area which gives it a good property to be used as gas sensors. However, many researchers use it for sensing layer without knowing which structural morphology gives the best sensor response. Therefore, it is worth investigating the effects of the structural morphology on the sensitivity as well as selectivity of the sensors.

Different methods have been used by different researchers for active layer fabrication like sputtering, air brushing, spin-coating, spraying etc. However, future researches should focus on direct synthesis of the sensing layer on the substrate for the sensor application because sensors that are fabricated using direct synthesis are more sensitive than sensors which the sensing layer was deposited due to the strong adhesion of the nanoparticles to the substrate.

Multi-sensing using gas sensor array is also a very good quality for an ideal gas sensing because of high response and recovery times [73]. Therefore, Future researches should focus on this property for gas sensing applications as it saves energy, power consumption, as well as small size. This capability makes it possible to develop only one sensor with the potentials of sensing more than one gas or atmospheric pollutants.

## Acknowledgements

The authors wish to thank the Ministry of Science and Technology and Innovation (MOSTI) Malaysia for their financial support.

## References

- [1]. L. M. Dorozhkin and I. A. Rozanov, Acoustic wave chemical sensors for gases, *Journal of Analytical Chemistry*, Vol. 56, No. 5, 2001, pp. 399–416.
- [2]. T. Hübert, L. Boon-Brett, G. Black, and U. Banach, Hydrogen sensors – A review, *Sensors and Actuators B: Chemical*, Vol. 157, No. 2, October 2011, pp. 329–352.
- [3]. J. G. Firth, A. Jones, T. Jones, The principles of the detection of flammable atmospheres by catalytic devices, *Combustible Flame*, Vol. 20, 1973, pp. 303–311.
- [4]. E. Jones, The pellistor catalytic gas detection, in: P. Moseley, B. Tofield (Eds.), *Solid State Gas Sensors*, Adam Hilger, Bristol, 1987, Chapter 2, pp. 17-31.
- [5]. T. Li, Lie Xu, et al., A high heating efficiency two-beam microplate for catalytic gas sensors, in *Proceedings of the IEEE International Conference on Micro Electronic and Mechanical Systems MEMS*, Kyoto, Japan, 2012, pp. 65–68.
- [6]. L. Xu, T. Li, X. Gao, and Y. Wang, Behaviour of a Catalytic Combustion Methane Gas Sensor Working on Pulse Mode, in *Proceedings of the IEEE International Conference on Sensors*, Kona, HI, USA, 1-4 November 2010, pp. 391–394.
- [7]. E.-B. Lee, I.-S. Hwang, J.-H. Cha, H.-J. Lee, W.-B. Lee, J. J. Pak, J.-H. Lee, and B.-K. Ju, Micromachined catalytic combustible hydrogen gas sensor, *Sensors and Actuators B: Chemical*, Vol. 153, No. 2, April 2011, pp. 392–397.
- [8]. W. Shin, M. Matsumiya, N. Izu, and N. Murayama, Hydrogen-selective thermoelectric gas sensor, *Sensors and Actuators B: Chemical*, Vol. 93, No. 1–3, August 2003, pp. 304–308.
- [9]. W. Shin, M. Matsumiya, F. Qiu, N. Izu, and N. Murayama, Thermoelectric gas sensor for detection of high hydrogen concentration, *Sensors and Actuators B: Chemical*, Vol. 97, No. 2–3, February 2004, pp. 344–347.
- [10]. Y.-J. Kim and S. S. Se-Chul Park, Seung-II Yoon, Chung-II Lee, A micro-thermoelectric gas sensor for the detection of hydrogen and atomic oxygen, *Analyst*, Vol. 134, 2009, pp. 236–242.
- [11]. S. Yoon, C. Lee, and Y. Kim, A thermoelectric gas sensor based on an embedded tin oxide catalyst for detecting hydrogen and NO<sub>x</sub> Gases, in *Proceedings of the IEEE 22<sup>nd</sup> International Conference on Micro Electro Mechanical Systems (MEMS '09)*, Sorrento, 25-29 January 2009, pp. 272–275.
- [12]. S. Anuradha, K. Rajanna, Development of thermoelectric gas sensors for volatile organic compounds, in *Proceedings of the 5<sup>th</sup> IEEE Conference on Sensors*, Daegu, 22-25 October 2006, pp. 716–718.
- [13]. P. Tardy, J.-R. Coulon, C. Lucat, and F. Menil, Dynamic thermal conductivity sensor for gas detection, *Sensors and Actuators B: Chemical*, Vol. 98, No. 1, March 2004, pp. 63–68.
- [14]. I. Simon and M. Arndt, Thermal and gas-sensing properties of a micromachined thermal conductivity sensor for the detection of hydrogen in automotive applications, *Sensors and Actuators A: Physical*, Vol. 97–98, April 2002, pp. 104–108.
- [15]. G. de Graaf and R. Wolffenbuttel, Surface-micromachined thermal conductivity detectors for gas sensing, in *Proceedings of the IEEE International Instrumentation and Measurement Technology Conference (I2MTC)*, Graz, 13-16 May 2012, pp. 1861–1864.
- [16]. J. F. Currie, A. Essalik, and J.-C. Marusic, Micromachined thin film solid state electrochemical CO<sub>2</sub>, NO<sub>2</sub> and SO<sub>2</sub> gas sensors, *Sensors and Actuators B: Chemical*, Vol. 59, No. 2–3, October 1999, pp. 235–241.
- [17]. R. Sathiyamoorthi, R. Chandrasekaran, T. Mathanmohan, B. Muralidharan, and T. Vasudevan, Study of electrochemical based gas sensors for fluorine and chlorine, *Sensors and Actuators B: Chemical*, Vol. 99, No. 2–3, May 2004, pp. 336–339.
- [18]. T. Gan and S. Hu, Electrochemical sensors based on graphene materials, *Microchimica Acta*, Vol. 175, No. 1–2, July 2011, pp. 1–19.
- [19]. G. H. Lu, L. E. Ocola, J. H. Chen, Reduced graphene oxide for room-temperature gas sensors, *Nanotechnology*, Vol. 20, 2009, pp. 445–502.
- [20]. Ting Zhang, Syed Mubeen, Nosang V. Myung and Marc A Deshusses, Recent progress in carbon nanotube-based gas sensors, *Nanotechnology*, Vol. 19, No. 33, 2008, Article ID 332001.
- [21]. Electrochemical Sensors, ([www.intlsensor.com](http://www.intlsensor.com)), pp. 27–35.
- [22]. X. Lu, S. Wu, L. Wang, and Z. Su, Solid-state amperometric hydrogen sensor based on polymer electrolyte membrane fuel cell, *Sensors and Actuators B: Chemical*, Vol. 107, No. 2, June 2005, pp. 812–817.
- [23]. K. Ho and W. Hung, An amperometric NO<sub>2</sub> gas sensor based on Pt/Na® on 1 Electrode, *Sensors and Actuators B: Chemical* Vol. 79, No. 2, 2001, pp. 11–16.
- [24]. Y. Chao, S. Yao, W. J. Buttner, and J. R. Stetter, Amperometric sensor for selective and stable hydrogen measurement, *Sensors and Actuators B: Chemical*, Vol. 106, No. 2, May 2005, pp. 784–790.

- [25]. A. Dutta, H. Nishiguchi, Y. Takita, and T. Ishihara, Amperometric hydrocarbon sensor using La(Sr)Ga(Fe)O<sub>3</sub> solid electrolyte for monitoring in exhaust gas, *Sensors and Actuators B: Chemical*, Vol. 108, No. 1–2, July 2005, pp. 368–373.
- [26]. D.-D. La, C. K. Kim, T. S. Jun, Y. Jung, G. H. Seong, J. Choo, and Y. S. Kim, Pt nanoparticle-supported multiwall carbon nanotube electrodes for amperometric hydrogen detection, *Sensors and Actuators B: Chemical*, Vol. 155, No. 1, July 2011, pp. 191–198.
- [27]. C. Phawachalotorn, O. Sanguanruang, and T. Ishihara, Highly selective amperometric sensors for carbon monoxide detection in exhaust gas, *Sensors and Actuators B: Chemical*, Vol. 161, No. 1, January 2012, pp. 635–640.
- [28]. C. Lee, S. A. Akbar, and C. O. Park, Potentiometric CO<sub>2</sub> gas sensor with lithium phosphorous oxynitride electrolyte, *Sensors and Actuators B: Chemical*, Vol. 80, No. 3, December 2001, pp. 234–242.
- [29]. J.-C. Yang and P. K. Dutta, High temperature potentiometric NO<sub>2</sub> sensor with asymmetric sensing and reference Pt electrodes, *Sensors and Actuators B: Chemical*, Vol. 143, No. 2, January 2010, pp. 459–463.
- [30]. Y. Yan, N. Miura, and N. Yamazoe, Potentiometric sensor using stabilized zirconia for chlorine gas, *Sensors and Actuators B: Chemical*, Vol. 24, No. 1, 1995, pp. 287–290.
- [31]. R. Radhakrishnan, A. V. Virkar, S. C. Singhal, G. C. Dunham, and O. A. Marina, Design, fabrication and characterization of a miniaturized series-connected potentiometric oxygen sensor, *Sensors and Actuators B: Chemical*, Vol. 105, No. 2, March 2005, pp. 312–321.
- [32]. C. Massie, G. Stewart, G. McGregor, and J. R. Gilchrist, Design of a portable optical sensor for methane gas detection, *Sensors and Actuators B: Chemical*, Vol. 113, No. 2, February 2006, pp. 830–836.
- [33]. L. N. Acquaroli, R. Urteaga, and R. R. Koropecski, Innovative design for optical porous silicon gas sensor, *Sensors and Actuators B: Chemical*, Vol. 149, No. 1, August 2010, pp. 189–193.
- [34]. H. Manap, R. Muda, S. O’Keeffe, and E. Lewis, Ammonia sensing and a cross sensitivity evaluation with atmosphere gases using optical fiber sensor, *Procedia Chemistry*, Vol. 1, No. 1, September 2009, pp. 959–962.
- [35]. S. Okazaki, H. Nakagawa, S. Asakura, Y. Tomiuchi, N. Tsuji, H. Murayama, and M. Washiya, Sensing characteristics of an optical fiber sensor for hydrogen leak, *Sensors and Actuators B: Chemical*, Vol. 93, No. 1–3, August 2003, pp. 142–147.
- [36]. M. Girschikofsky, M. Rosenberger, S. Belle, M. Brutschy, S. R. Waldvogel, and R. Hellmann, Optical planar Bragg grating sensor for real-time detection of benzene, toluene and xylene in solvent vapour, *Sensors and Actuators B: Chemical*, Vol. 171–172, No. 2010, August 2012, pp. 338–342.
- [37]. H. Okajima, S. Kakuma, K. Uchida, Y. Wakimoto, K. Noda, Measurement of methane gas concentration using infrared LED, in *Proceedings of the International Joint Conference SICE-ICASE*, Busan, 18-21 Oct. 2006 pp. 1656–1659.
- [38]. D. Garcia Romeo, A. Martínez, and C. Azcona, NDIR-based CO<sub>2</sub> Monitor System for Wireless Sensor Networks, *IEEE Latin American Symposium on Circuits and Systems LASCAS*, Playa Del Carmen, 29 February - 2 March 2012, pp.1-4.
- [39]. D. Chen, W. Liu, Y. Zhang, J. Liu, R. Kan, M. Wang, J. Chen, and Y. Cui, H<sub>2</sub>S detection by tunable diode laser absorption spectroscopy, in *Proceedings of the IEEE International Conference on Information Acquisition*, Shandong, 20-23 August 2006, pp. 754–758.
- [40]. G. Zhang, Y. Li, and Q. Li, A miniaturized carbon dioxide gas sensor based on infrared absorption, *Optics and Lasers in Engineering*, Vol. 48, No. 12, December 2010, pp. 1206–1212.
- [41]. N. Kasai, C. Tsuchiya, T. Fukuda, K. Sekine, T. Sano, and T. Takehana, Propane gas leak detection by infrared absorption using carbon infrared emitter and infrared camera, *NDT & E International*, Vol. 44, No. 1, January 2011, pp. 57–60.
- [42]. J. Huang and Q. Wan, Gas sensors based on semiconducting metal oxide one-dimensional nanostructures, *Sensors*, Vol. 9, No. 12, January 2009, pp. 9903–9924.
- [43]. A. Khodadadi, S. S. Mohajerzadeh, Y. Mortazavi, and A. M. Miri, Cerium oxide / SnO<sub>2</sub>-based semiconductor gas sensors with improved sensitivity to CO, *Sensors and Actuators B: Chemical*, Vol. 80, No. 3, 2001, pp. 267–271.
- [44]. Principles of Gas Detection ([www.honeywell.com](http://www.honeywell.com)).
- [45]. G. Korotcenkov, Practical aspects in design of one-electrode semiconductor gas sensors: Status report, *Sensors and Actuators B: Chemical*, Vol. 121, No. 2, February 2007, pp. 664–678.
- [46]. K. Shimanoe, M. Yuasa, T. Kida, and N. Yamazoe, Semiconductor gas sensor using nano-sized oxide for high-sensitive detection of environment-related gases, in *Proceedings of the IEEE International Conference on Nanotechnology Materials and Devices*, October 2011, pp. 38–43.
- [47]. T. Takada, T. Fukunaga, and T. Maekawa, New method for gas identification using a single semiconductor sensor, *Sensors and Actuators B: Chemical*, Vol. 66, No. 1–3, July 2000, pp. 22–24.
- [48]. R. Konishi, The concentration-estimation of inflammable gases with a semiconductor gas sensor utilizing neural networks and fuzzy inference, *Sensors and Actuators B: Chemical*, Vol. 41, No. 1-3, 1997, pp. 121–129.
- [49]. G. Halek, M. Malewicz, and H. Teterycz, Methods of selectivity improvements of semiconductor gas sensors, in *Proceedings of the International Students and Young Scientists Workshop on Photonics and Microsystem*, Wernigerode, 25-27 June 2009, pp. 31–35.
- [50]. W. H. King, Piezoelectric sorption detector, *Analytical Chemistry*, Vol. 36, 1964, pp. 1735–1739.
- [51]. C. Lim, W. Wang, S. Yang, and K. Lee, Development of SAW-based multi-gas sensor for simultaneous detection of CO<sub>2</sub> and NO<sub>2</sub>, *Sensors and Actuators B: Chemical*, Vol. 154, No. 1, May 2011, pp. 9–16.
- [52]. G. Fischerauer, F. Dickert, P. Forth, and U. Knauer, Chemical sensors based on SAW resonators working at up to 1 GHz, in *Proceedings of the IEEE Ultrasonics Symposium*, 1996, Vol. 1, pp. 439–442.
- [53]. M. N. Hamidon, V. Skarda, N.M. White, F. Krispel, P. Krempel, M. Binhack, W. Buff, Fabrication of high temperature surface acoustic wave devices for sensor applications, *Sensors and Actuators A*, Vol. 123, Issue 1, 2005, pp. 403–407.

- [54]. Daniel R. Raichel, Modern applications of acoustics, Springer-Verlag GmbH, 2000.
- [55]. H. Wohltjen and R. Dessy, Surface acoustic wave probe for chemical analysis, I Introduction and instrument description, II Gas chromatography detector, III Thermomechanical polymer analyzer, *Analytical Chemistry*, Vol. 51, 1979, pp. 1458–1478.
- [56]. M. S. Nieuwenhuizen and A. J. Nederlof, A SAW gas sensor for carbon dioxide and water. Preliminary experiments, *Sensors and Actuators B: Chemical*, Vol. 2, No. 2, May 1990, pp. 97–101.
- [57]. A. Venema, E. Nieuwkoop, W. J. Ghijsen, A. W. Barendsz, and M. S. Nieuwenhuizen, NO<sub>2</sub> Gas-concentration measurement with a SAW chemosensor, *IEEE Transactions on Ultrasonics, Ferroelectrics and Frequency Control*, Vol. 34, Issue 2, 1987, pp. 148–155.
- [58]. V. I Anisimkin, M. Penza, A. Valentini, F. Quaranta, L. Vasanelli, Detection of combustible gases by means of a ZnO-on-Si surface acoustic wave (SAW) delay line, *Sensors and Actuators B: Chemical*, Vol. 23, 1995, pp. 197–201.
- [59]. K. Beck, T. Kunzelmann, M. Von Schickfus, and S. Hunklinger, Contactless surface acoustic wave gas sensor, *Sensors and Actuators*, Vol. 76, No. 1-3, Augusto 1999, pp. 103–106.
- [60]. H. Lee, D. Han, and H. Ahn, Design and fabrication of SAW gas sensor with resonator structure, in *Proceedings of the 5<sup>th</sup> International Conference on Properties and Applications of Dielectric Materials*, Seoul, 25-30 May 1997, Vol. 2, pp. 1058–1061.
- [61]. J. A. Thiele and M. P. Cunha, Dual configuration high temperature hydrogen sensor on LGS SAW devices, in *Proceedings of the IEEE Ultrasonics Symposium*, 2004, pp. 809–812.
- [62]. A. Z. Sadek, W. Wlodarski, K. Shin, R. B. Kaner, and K. Kalantar-Zadeh, A room temperature polyaniline / SnO<sub>2</sub> nanofiber composite based layered ZnO / 64 ° YX LiNbO<sub>3</sub> SAW hydrogen gas sensor, in *Proceedings of the International Conference on Proceedings of the Optoelectronic and Microelectronic Materials and Devices Conference (COMMAD '06)*, Perth, W. A., Australia, 6-8 December 2006, pp. 208–211.
- [63]. A. Z. Sadek, W. Wlodarski, Y. Li, W. Yu, X. Li, and X. Yu, A ZnO nanorod based 64 degrees YX LiNbO<sub>3</sub> surface acoustic wave CO sensor, in *Proceedings of the IEEE International Conference on Sensors*, 2006, Vol. 6, pp. 691–694.
- [64]. M. Penza, R. Rossi, M. Alvisi, P. Aversa, G. Cassano, D. Suriano, M. Benetti, D. Cannata, F. Di Pietrantonio, and E. Verona, SAW gas sensors with carbon nanotubes films, in *Proceedings of the IEEE Ultrasonics Symposium*, Nov. 2008, Vol. 1, pp. 1850–1853.
- [65]. C. Lim, S. Yang, and K. Lee, Simultaneous and wireless measurement of CO<sub>2</sub> and NO<sub>2</sub> using a saw reflective delay line, in *Proceedings of the International Conference on Solid-State Sensors, Actuators and Microsystems (TRANSDUCERS'09)*, Denver, CO, 21-25 June 2009, pp. 995–998, 2009.
- [66]. C. Viespe and C. Grigoriu, Surface acoustic wave sensors with carbon nanotubes and SiO<sub>2</sub>/Si nanoparticles based nanocomposites for VOC detection, *Sensors and Actuators B: Chemical*, Vol. 147, No. 1, May 2010, pp. 43–47.
- [67]. D. Yao and M. Chen, Gas sensor array based on surface acoustic wave devices for vapors detection and analysis, in *Proceedings of the IEEE 5<sup>th</sup> International Conference on Nano/Micro Engineered and Molecular Systems*, January 2010, Vol. 1, pp. 267–271.
- [68]. H. Hao, M. Chen, and T. Lin, A chemical surface acoustic wave (SAW) sensor array for sensing different concentration of NH<sub>3</sub>, in *Proceedings of the IEEE 5<sup>th</sup> International Conference on Nano/Micro Engineered and Molecular Systems*, January 2010, Vol. 10, pp. 1092–1096.
- [69]. C. Shen, C. Hsu, M. Su, R. Tsai, and S. Wang, Propagation characteristics of surface acoustic wave and properties of gas sensors on quartz, in *Proceedings of the IUTAM Symposium on Recent Advances of Acoustic Waves in Solids*, Vol. 26, 2010, pp. 293–302.
- [70]. T. H. Lin, Y. T. Li, H. C. Hao, I. C. Fang, C. M. Yang, D. J. Yao, Surface acoustic wave gas sensor for monitoring low concentration ammonia, in *Proceedings of the IEEE 16<sup>th</sup> International Conference on Solid-State Sensors, Actuators and Microsystems (Transducers'2011)*, Beijing, 5-9 June 2011 pp. 1140–1143.
- [71]. D.-T. Phan and G.-S. Chung, Surface acoustic wave hydrogen sensors based on ZnO nanoparticles incorporated with a Pt catalyst, *Sensors and Actuators B: Chemical*, Vol. 161, No. 1, January 2012, pp. 341–348.
- [72]. M. H. S. Abadi, M. N. Hamidon, A. H. Shaari, N. Abdullah, R. W. And, and N. Misron, Nanocrystalline SnO<sub>2</sub>-Pt thick film gas sensor for Air pollution applications, *Sensors and Transducers*, Vol. 125, No. 2, 2011, pp. 76–88.
- [73]. M. H. Shahrokh Abadi, M. N. Hamidon, A. H. Shaari, N. Abdullah, and R. Wagiran, SnO<sub>2</sub>/Pt thin film laser ablated gas sensor array, *Sensors*, Vol. 11, No. 8, January 2011, pp. 7724–7735.